

GGD Filters

Pleated Fiberglass Depth Media



GGD filters are part of Critical Process Filtration's economical, general service product line that can be used to lower the total cost of filtration from simple to the most complex applications. Produced using the same quality materials and manufacturing excellence as our other product lines, you can be assured of their performance, dependability and scalability. While general service filters are not integrity tested or validated for retention, these highly efficient filters remove large amounts of contaminants early in the process to reduce the load on your expensive downstream filters. They are also useful as stand-alone clarifying or particle removal filters in less critical applications.

GGD cartridge and capsule filters are constructed with **fiberglass depth media** for clarification and prefiltration of liquids and gases. Pore sizes range from 0.22 to 30 μm . GGD filters are capable of retaining large amounts of particulates and contaminants which translates to longer filter life and lower costs.

Critical Process provides unrivaled delivery times, technical consulting before purchasing, and very competitively priced high-performance products. Our comprehensive testing & analysis and validation services support your team whenever they need it. Your process experts partnering with our filtration experts is how we deliver your company's solution right the first time.

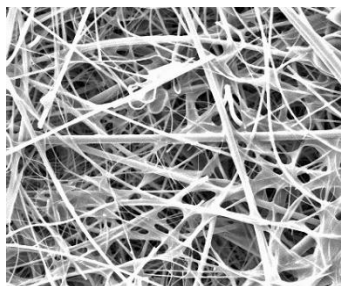

GGD filters are recommended for the clarification & prefiltration of:

- Chemicals
- Acids & Bases
- Inks & Dyes
- Process Water
- Air & Gases

Clarification & Prefiltration



CARTRIDGES – Nominal Dimensions

Length: 5 to 40 in. (12.7 to 101.6 cm)
Outside Diameter: 2.75 in. (7.0cm)



CAPSULES – Nominal Dimensions

Length: 2 to 30 in. (5.1 to 76.2 cm)
Outside Diameter: 3.50 in. (8.9 cm)

Maximum Operating Parameters

	CARTRIDGES	CAPSULES
Liquid Operational Pressure	N/A	80 psi at 68 °F (5.51 bard at 20 °C)
Gases Operational Pressure	N/A	60 psi at 68 °F (4.13 bar at 20 °C)
Operating Temperature (water)	180 °F at 30 psid (82 °C at 2.06 bard)	110 °F at 30 psid (43 °C at 2.06 bard)
Forward Differential Pressure	80 psid at 68 °F (5.51 bard at 20 °C) (Liquid and Gas)	Liquid - 80 psid at 68 °F (5.51 bard at 20 °C) Gas - 60 psi at 68 °F (4.13 bar at 20 °C)
Reverse Differential Pressure	50 psid at 68 °F (3.44 bard at 20 °C)	50 psid at 68 °F (3.44 bard at 20 °C)
Recommended Changeout Pressure	35 psid (2.41 bard)	35 psid (2.41 bard)

Sanitization & Sterilization

Filtered Hot Water*	90 °C (194 °F), 30 minutes, multiple cycles, max 3 psid forward flow	N/A
Inline Steam*	275 °F (135 °C), 30 min, 25+ cycles	N/A
Autoclave*	250 °F (121 °C), 30 min, 25+ cycles	250 °F (121 °C), 30 min, 25+ cycles
Chemical Sanitization	Performed using industry standard concentrations of hydrogen peroxide, peracetic acid, sodium hypochlorite and other selected chemicals.	

*Cartridge Filters – For all elevated temperature procedures above, a stainless-steel support ring is required.

Filtration Area

	CAPSULES	CARTRIDGES AND CAPSULES				CARTRIDGES
Length	2" 5.08cm	5" 12.7cm	10" 25.4cm	20" 50.8cm	30" 76.2cm	40" 101.6cm
Area	0.8 ft ² 0.08m ²	2.3 ft ² 0.22m ²	5.0 ft ² 0.46m ²	10.0 ft ² 0.92m ²	15.0 ft ² 1.38m ²	20.0 ft ² 1.84m ²

Extractables

GGD filters typically exhibit low levels of non-volatile residues.

Non-Fiber Releasing

The GGD filters comply with Title 21 CFR sections 210.3 (b)(6) and 211.72, for non-fiber releasing filters.

FDA Compliance

Materials meet the requirements listed by the FDA as appropriate for use in articles intended for repeated food contact as specified in Title 21 CFR sections 174.5, 177.1500, 177.1520, 177.1630, 177.2440, and 177.2600 as applicable.

Construction Materials

Filtration Media Pleated Fiberglass Depth Media

Media Support Polypropylene

End Caps, Center Core, Outer Support Cage, Capsule Housing Polypropylene

Sealing Method Thermal Bonding

O-Rings/Gaskets Cartridges only Buna, Viton® (or FKM), EPDM, Silicone, FEP Encapsulated Silicone, FEP Encapsulated Viton (or FKM)

Flow Rates for GGD Cartridges

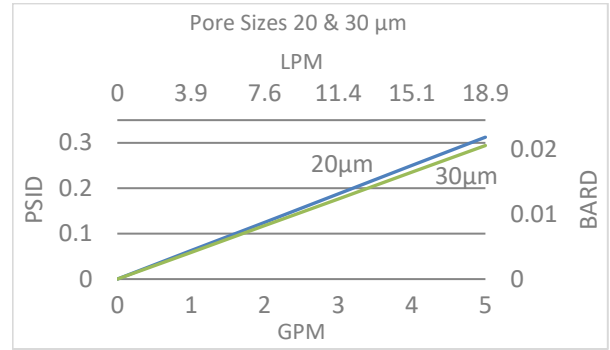
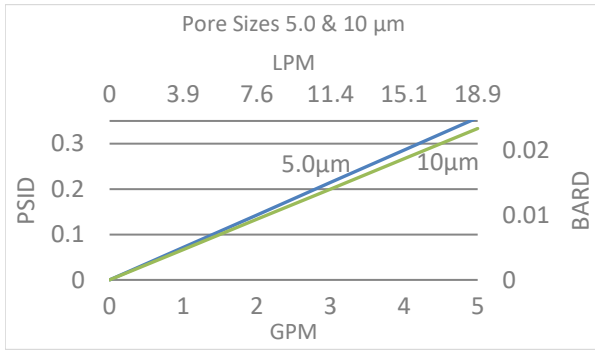
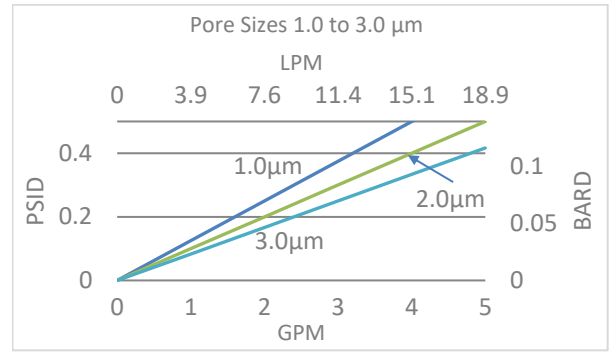
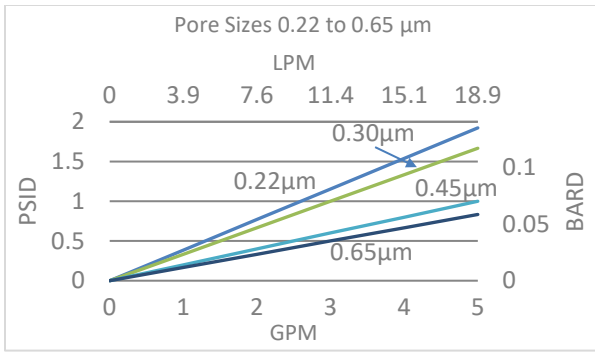

Flow rates for Cartridge filters are per 10-inch length. The test fluid is water at ambient temperature.

Flow Rates for GGD Capsules

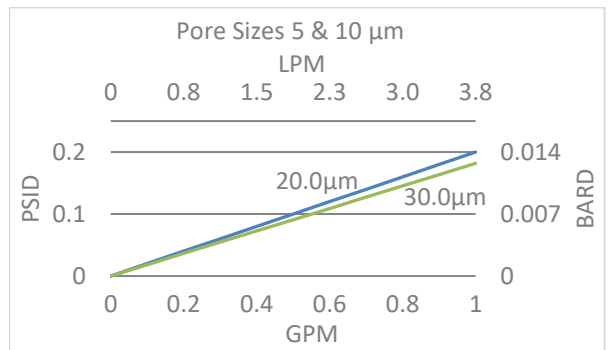
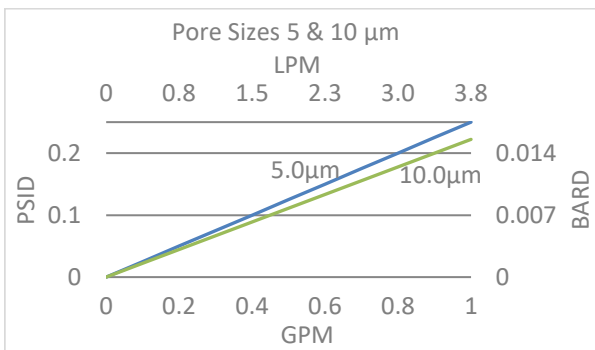
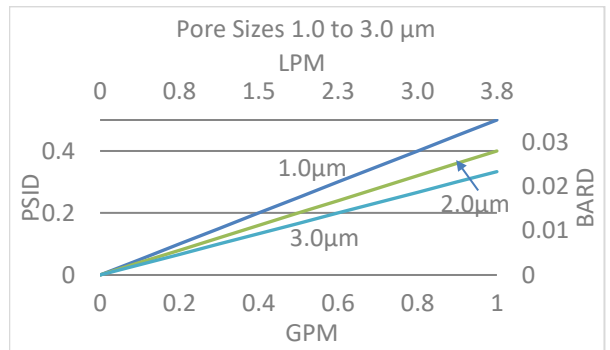
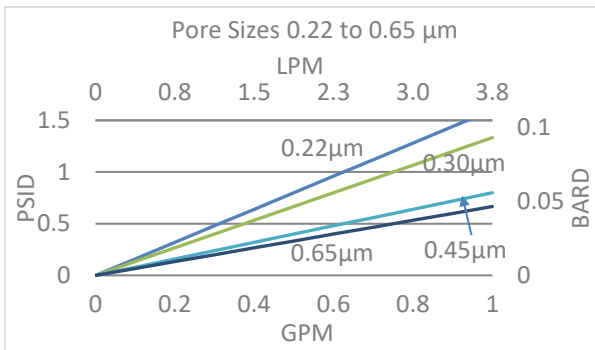

Flow rates for capsule filters are per square foot of membrane area. The test fluid is water at ambient temperature. Flows are tested using a 2" capsule filter with 1/2" FNPT inlet and outlet ports. Rates will vary based on end configuration of the capsule.

GGD Filters Ordering Information

All Critical Process filters are configurable to meet customer specifications.
Fill in the corresponding codes in the boxes below to build your Part Number.

To consult with one of our technical team members, request a quote or place an order:
call (603) 880-4220 Ext. 106, or send an email to sales@criticalprocess.com

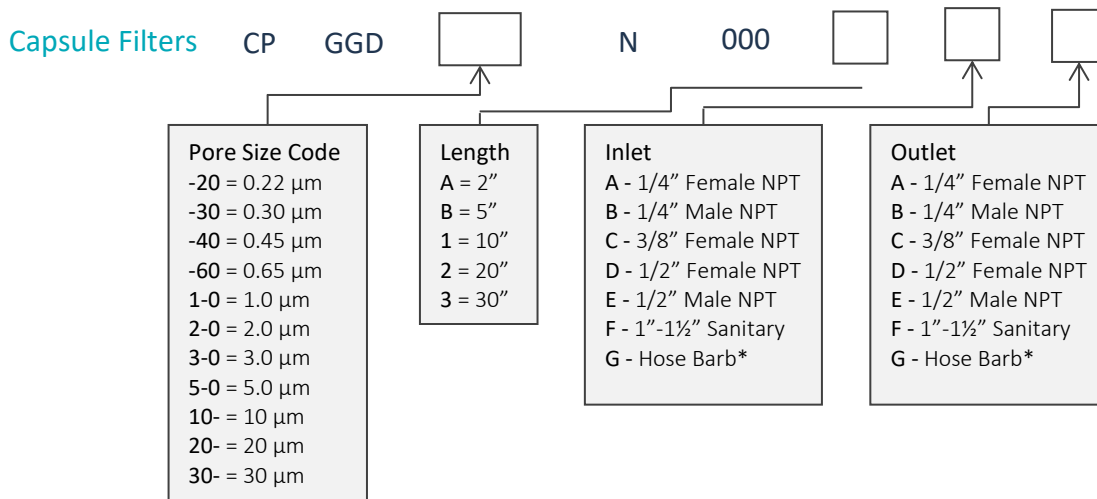
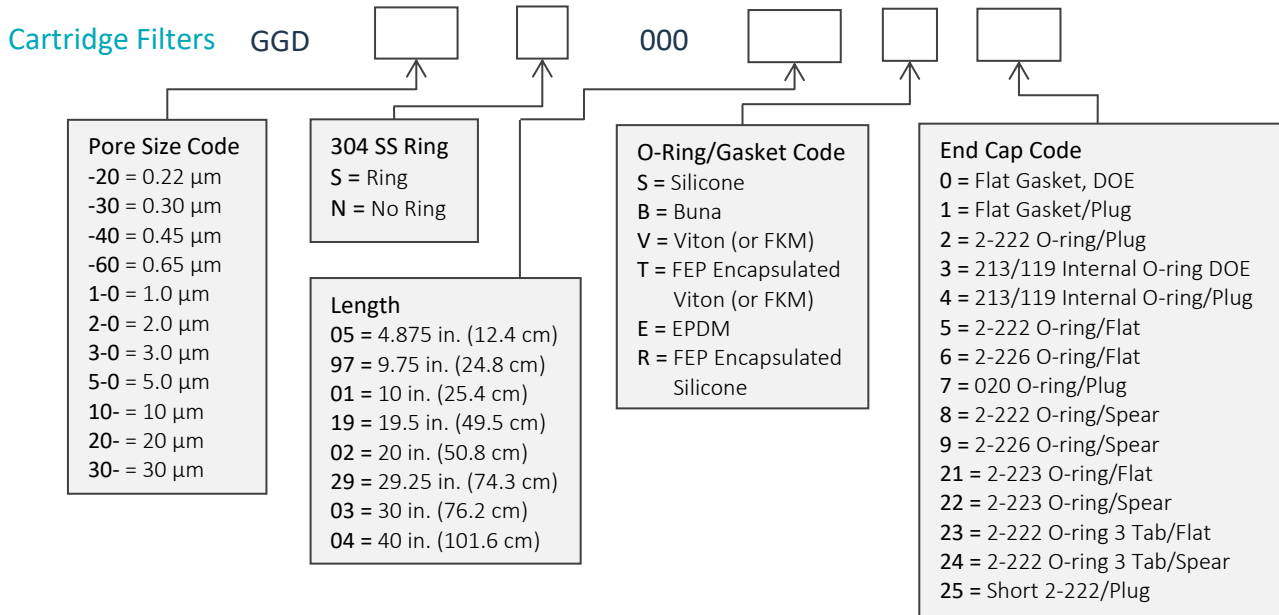

Housings

CPF offers Model CSH sanitary housings in Single-Round (Inline and T-Style) and Multi-Round (3, 6, 8, 12 and 21-round) configurations.

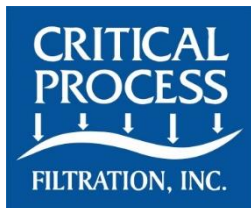

One Chestnut Street
Nashua, NH 03060
603.880.4420
FAX: 603.880.4536
CriticalProcess.com

The information contained herein is subject to change without notice. The Critical Process Filtration logo is a trademark of Critical Process Filtration, Inc. Viton is a trademark of DuPont Performance Elastomers L.L.C.
© 1998-2020 Critical Process Filtration, Inc. • All Rights Reserved

Data Sheet GGDS0919 RevA